



Restore. Regrow. Renew.

# OSSIOfiber<sup>®</sup> Suture Anchor

Rotator Cuff Arthroscopic Surgical Technique Guide



# Safety Unmatched

## Bio-Integrative OSSIOfiber®

A first-of-its-kind material technology that delivers peace of mind through predictable implant integration without encapsulation or adverse inflammation.

12 Months

24 Months

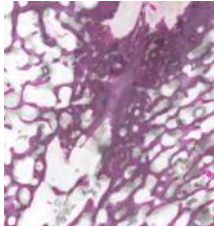
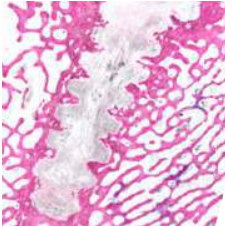

OSSIOfiber® Suture Anchor

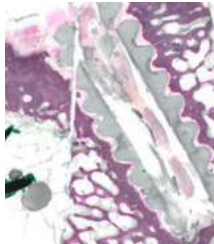
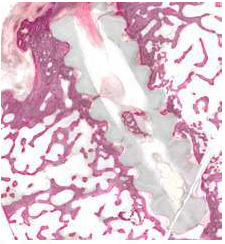

Biocomposite Anchor (Control)

### OSSIOfiber® Delivers:

#### Early Bone Formation

At 1 and 2 Years OSSIOfiber® showed superior cellular ingrowth and bone replacement.

#### Full Integration

No implant remaining and advanced bone remodeling at two years.

#### Optimal Biocompatibility

OSSIOfiber® showed no adverse inflammatory response.

# Strength Unrivaled

Have confidence knowing OSSIOfiber® Suture Anchors provide superior initial pull-out resistance and maintain strength vs the leading biocomposite anchor.

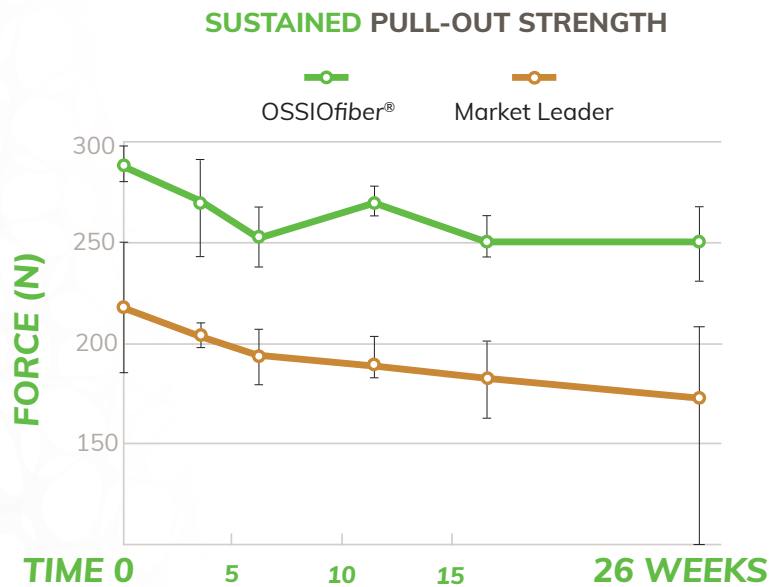

# Design Features

## OSSIOfiber® Suture Anchor

### Upgrade To A New Standard



**DURALink™  
Coupling Technology**

Designed to increase construct stability and minimize suture slippage, our proprietary DURALink™ technology couples the OSSIOfiber® eyelet to the anchor, creating a single stable unit.



**OSSIOfiber® Suture Eyelet**  
Enlarged eyelet for additional suture options

**OSSIOfiber® 4.75mm and 5.5mm\* Suture Anchors**  
Improved strength and pull-out resistance

**High-Strength UHMWPE Tape & Round Sutures**  
Multiple sutures for custom constructs

**Suture Organizer**  
Safe and easy suture management.

**Suture Snare**  
Efficient snaring wire to ease suture capture

**Release Tab**  
For easy inserter removal

\*5.5mm Suture Anchors available in Suture Snare configuration only

## 4.75 Anchor Punch

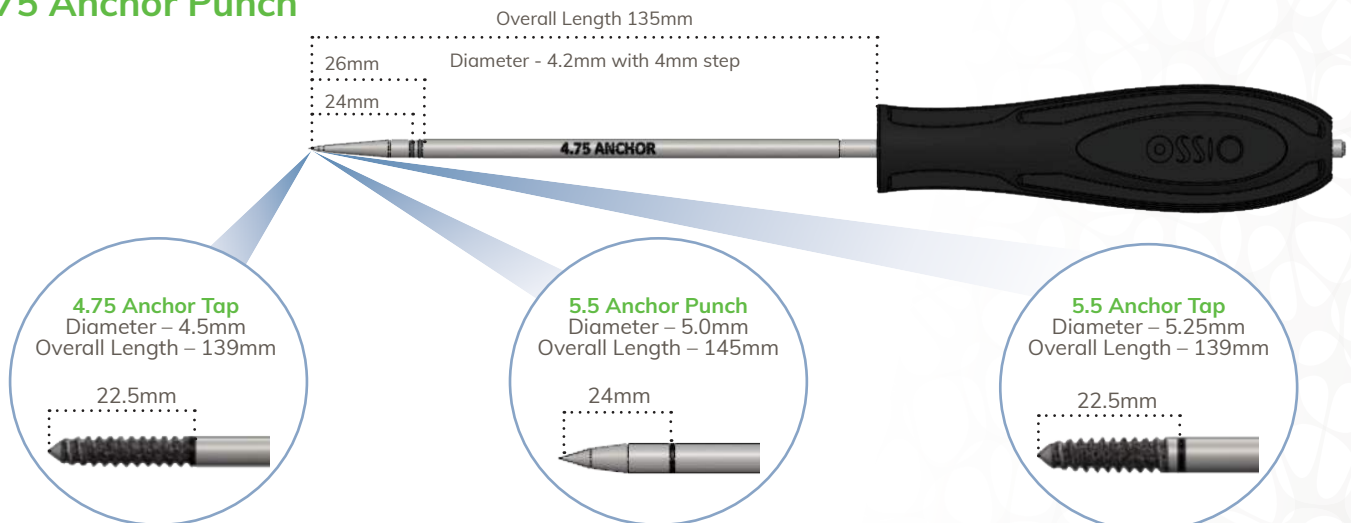

Overall Length 135mm  
Diameter - 4.2mm with 4mm step

26mm  
24mm

**4.75 Anchor Tap**  
Diameter - 4.5mm  
Overall Length - 139mm

**5.5 Anchor Punch**  
Diameter - 5.0mm  
Overall Length - 145mm

**5.5 Anchor Tap**  
Diameter - 5.25mm  
Overall Length - 139mm

22.5mm  
24mm  
22.5mm

# Double Row Repair Surgical Technique

1

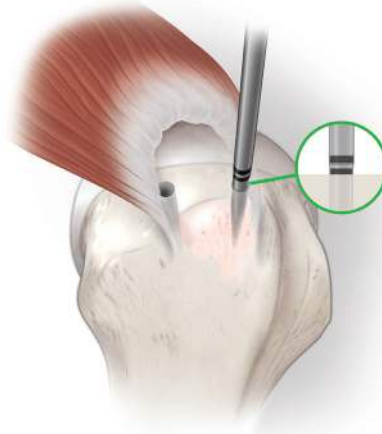

## Medial Row Bone Preparation

Prepare two bone holes in the medial row using the OSSIO punch. Advance the punch to the first laser line.

Take care to ensure that the punch trajectory and location allows for adequate bone fixation.

**NOTE:** Advance the punch to the second laser line in hard bone

2

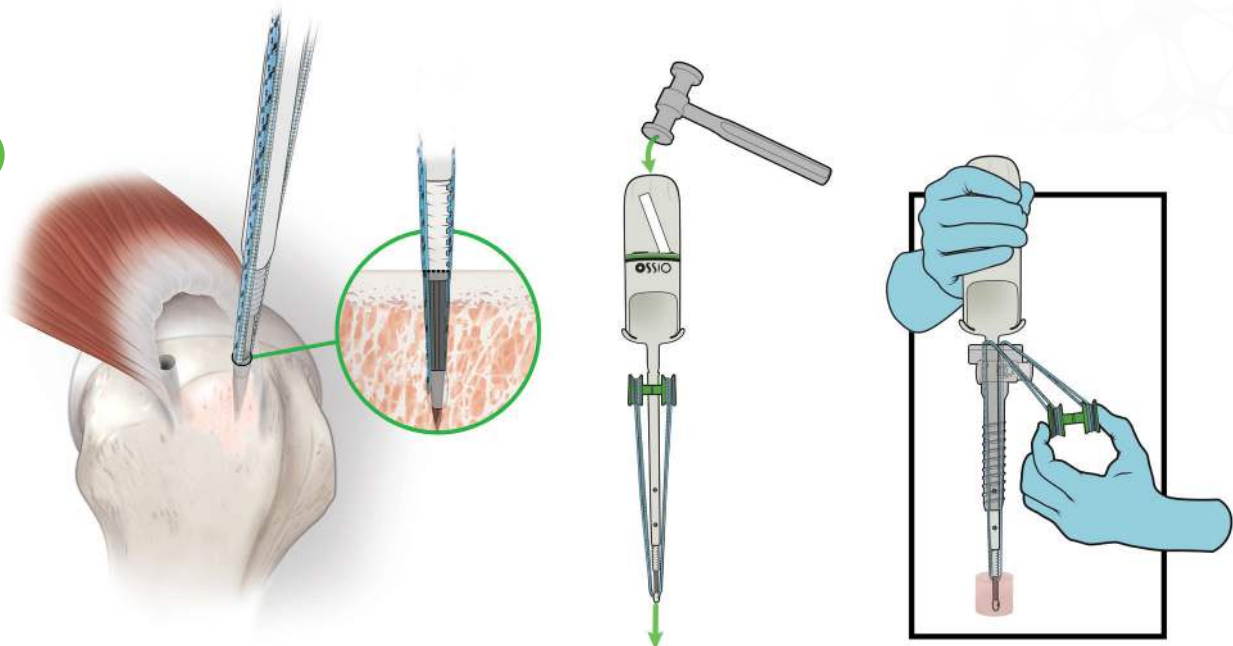

## Medial Row Eyelet Insertion

Insert the eyelet of the OSSIOfiber® suture anchor preloaded with sutures into the prepared bone hole. Using a mallet gently tap the end of the suture anchor handle until the first thread of the anchor is below the surface

**TIP:** If utilizing a cannula remove the suture organizer from the white inserter once the anchor is inside

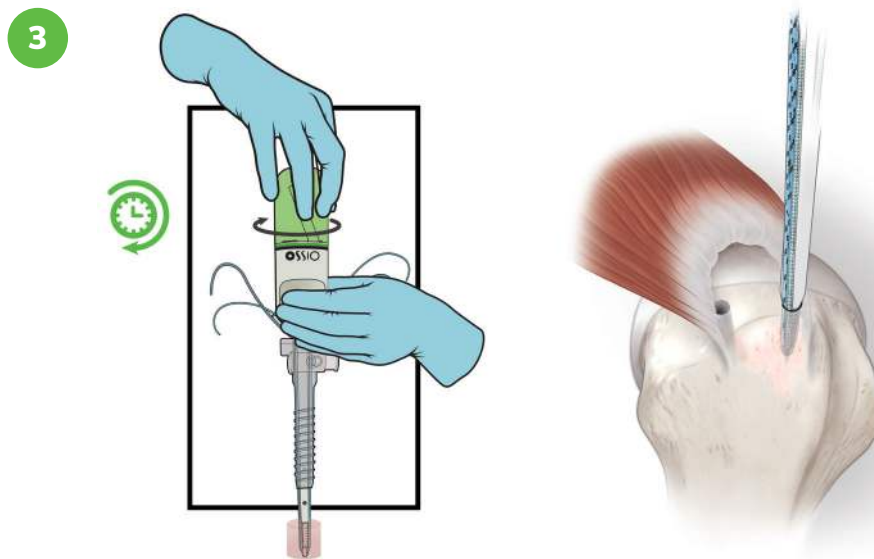

### Medial Row Anchor Insertion

Apply slight axial pressure while holding the stabilization handle of the driver with the non-dominant hand, turn the driver handle in a clockwise direction with the dominant hand to drive the OSSIOfiber® suture anchor into the bone.

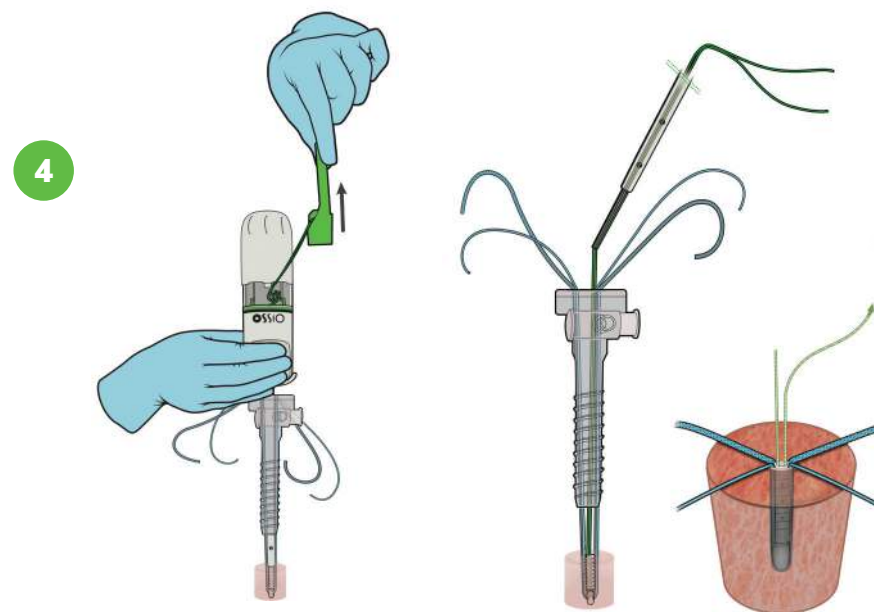

### Inserter Removal

To disengage the driver from the suture anchor, first remove the inner suture release tab from the handle by grasping firmly and pull up axially along the handle. This opens the inner suture compartment and releases the retaining suture. The driver can be disengaged from the anchor.

A #1 round inner suture used to hold the eyelet to the driver will be exposed as the driver is removed. Remove this suture by pulling on one end until fully detached. Alternatively, the inner suture can be used for additional fixation of the tendon.

5

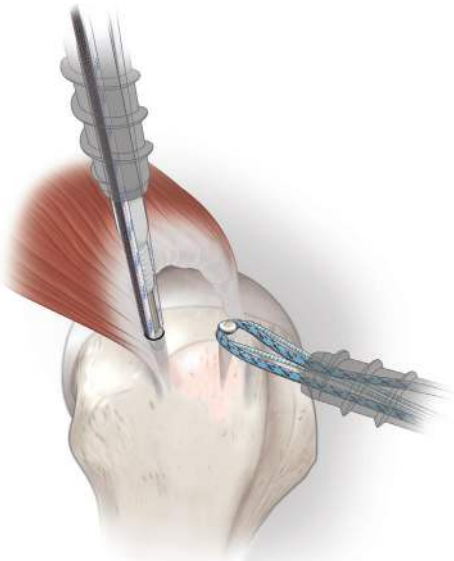

### 2nd Medial Row Anchor Insertion

Repeat anchor insertion steps for the opposite side of the medial row.

**NOTE:** Multiple tape and round color options are available to help differentiate between sutures

**TIP:** After the driver is removed, the hex-shaped portion of the driver can be reengaged into the anchor if further adjustment is needed.

6

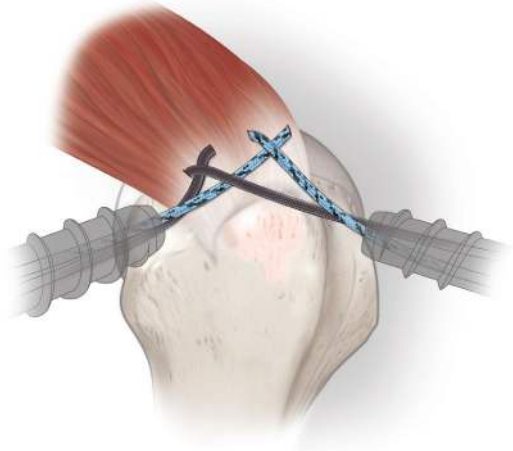

### Suture Passing

Load sutures onto a suture passer and pass each limb through the rotator cuff. Tension each limb to remove slack from underneath the tendon.

Both the suture tape and/or #2 round suture can be used in the construct fixation.

Alternatively, the #2 round sutures can be placed in a ripstop configuration.

7

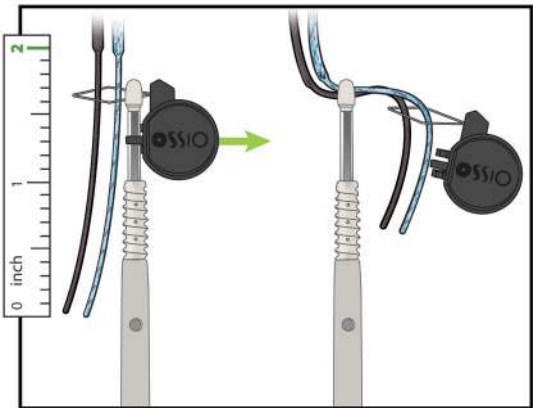

### Suture Retrieval

Grabbing one end of suture limb from each medial row anchors, thread both ends through the stand-alone suture anchor snare.

Pull the snare handle away from the anchor, passing both suture ends through the eyelet.

**TIP:** To help ease passing of suture have no more than 2 inches of suture limb loaded through the snare prior to pulling the snare handle.

8



### Lateral Row Bone Preparation

Prepare two bone holes in the lateral row using the OSSIO punch as described previously.

Take care to ensure that the punch trajectory and location allows for adequate bone fixation.

9

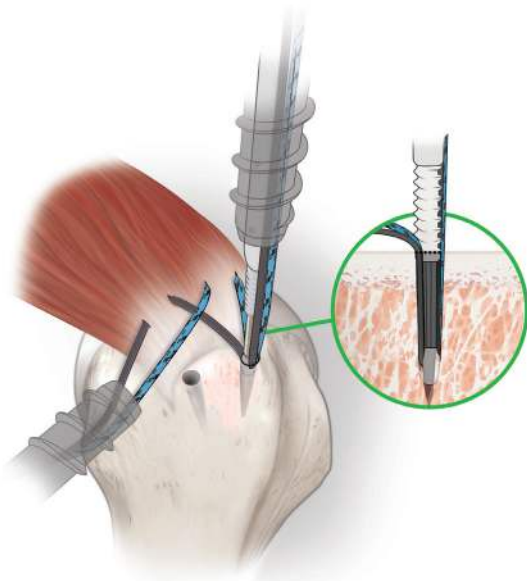

### Lateral Row Eyelet Insertion

Approximate the eyelet to the prepared bone hole and adjust tension to remove slack in the sutures by pulling on the free limbs. Utilize the cleats to help maintain desired suture tension. Insert the eyelet into the prepared hole as described in the previous step.

8

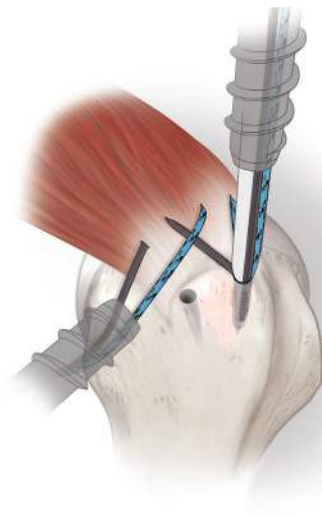

### Lateral Row Anchor Insertion

If satisfied with suture tension apply slight axial pressure and insert the OSSIOfiber® suture anchor into the bone per the technique previously described. Repeat these steps for the second lateral row anchor.

**NOTE:** If not satisfied with suture tension remove the inserter and readjust prior to threading anchor into the bone.

11



### Cut Sutures

Cut the ends of all sutures to be flush with the bone to complete the construct.

12



### Optional Rip Stop Technique

One limb of #2 round sutures from each medial row anchor can be passed through and tied medially where their respective opposite ends pass through the lateral row anchors to create a rip stop suture technique.

# Intelligent Healing For Arthroscopic Tendon Repair



**OSSIofiber®**  
**4.75mm Suture Anchor**  
 Blue/Black Tape , #2 suture  
 P/N OF1034755S



**OSSIofiber®**  
**4.75mm Suture Anchor**  
 Black Tape, #2 suture  
 P/N OF1034754S



**OSSIofiber®**  
**4.75mm and 5.5mm**  
**Suture Anchor**  
 w/ Snare, No Suture  
 P/N OF1034751S (4.75mm)  
 P/N OF1035551S (5.5mm)

## Ordering Information

### Arthroscopic Procedure Item Numbers

OF2034750S*	OSSIofiber® Suture Anchor System, 2x4.75 Anchors
OF1034751S	OSSIofiber® Suture Anchor w/ Snare, 4.75
OF1034754S	OSSIofiber® Suture Anchor, 4.75 Black Tape & #2 Sutures
OF1034755S	OSSIofiber® Suture Anchor, 4.75 Bl/Bk Tape & #2 Sutures
THN00241	OSSIO Punch for 4.75 mm Suture Anchor
THN00239	OSSIO Tap for 4.75 mm Suture Anchor
OF1032001S	Solid Black 2mm Tape Suture, Box of 12
OF1032002S	Blue Black 2mm Tape Suture, Box of 12
OF1035551S	OSSIofiber® Suture Anchor w/ Snare, 5.5
THN00236	OSSIO Punch for 5.5 mm Suture Anchor
THN00240	OSSIO Tap for 5.5mm Suture Anchor

\*OSSIofiber® 4.75 Suture Anchor System contains 2 anchors w/ snare, 1 punch instrument, 1 pack solid black 2mm tape suture, and 1 pack blue black 2mm tape suture.



## Indication for Use

The OSSIOfiber® Suture Anchors are indicated for fixation of suture (soft tissue) to bone in the shoulder, foot/ankle, knee, hand/wrist, and elbow in the following procedures:

- Shoulder: Rotator Cuff Repair, Bankart Repair, SLAP Lesion Repair, Biceps Tenodesis, Acromio-Clavicular Separation Repair, Deltoid Repair, Capsular Shift or Capsulolabral Reconstruction.
- Foot/Ankle: Lateral Stabilization, Medial Stabilization, Achilles Tendon Repair, Hallux Valgus Reconstruction, Mid-foot Reconstruction, Metatarsal Ligament Repair/Tendon Repair and Bunionectomy.
- Knee: Anterior Cruciate Ligament Repair (4.75-5.5 Anchors Only), Medial Collateral Ligament Repair, Lateral Collateral Ligament Repair, Patellar Tendon Repair, Posterior Oblique Ligament Repair, Iliotibial Band Tenodesis and Quadriceps Tendon Repair. Secondary or adjunct fixation of ACL/PCL reconstruction or repair (4.75 – 5.5 Anchors only).
- Hand/Wrist: Scapholunate Ligament Reconstruction, Ulnar or Radial Collateral Ligament Reconstruction.
- Elbow: Biceps Tendon Reattachment, Ulnar or Radial Collateral Ligament Reconstruction, Lateral Epicondylitis repair (Tennis Elbow).

1. Data on File at OSSIO.

Refer to the product Instructions for Use for warnings, precautions, indications, contraindications, and technique.

DOC-0002667 Rev02 10/2023

® OSSIO and OSSIOfiber® are registered trademarks of OSSIO Ltd. All rights reserved. Not available for sale in all geographies. Speak to your local sales representative or distributor for product availability.

OSSIO Inc. 300 Tradecenter Drive, Suite 3690, Woburn, MA 01801  
For more on OSSIO and OSSIOfiber®, please visit [ossio.io](http://ossio.io) or call 833-781-7373

